

GALLONS PER HOUR

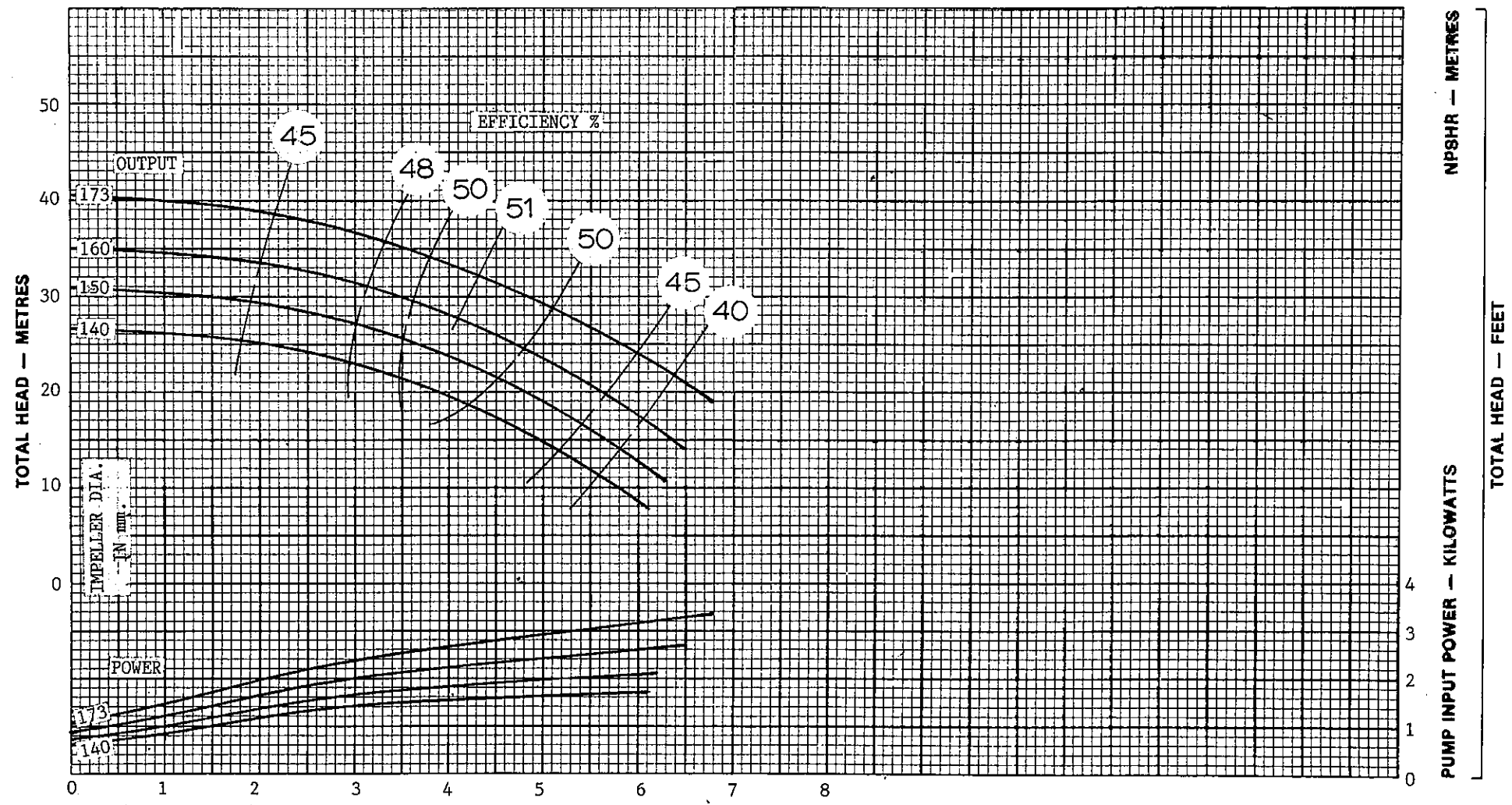

**F.L. STALKER & SONS PTY. LTD.**  
 24 STALKER ROAD, GOSNELLS, W.A.  
 Tel: 396 2133  
 Telex: AA96302

FLOW — LITRES PER SECOND

PUMP SIZE & TYPE 32 S.H.L.		CLIENT		CURVE NO 12059
IMPELLOR DIA VARIABLE	RPM 2900	DATE 12/11/90	DRN BY R. SCADDAN	

ALL QUALITY ENGINEERED AND MANUFACTURED IN W.A.  
 WITH OVER 66 YEARS EXPERIENCE

INSTALLATION, REPAIRS AND SERVICE BORE TESTING  
 & EQUIPMENT, HIRE PUMPS, RE-WINDS (24 Hour Service)

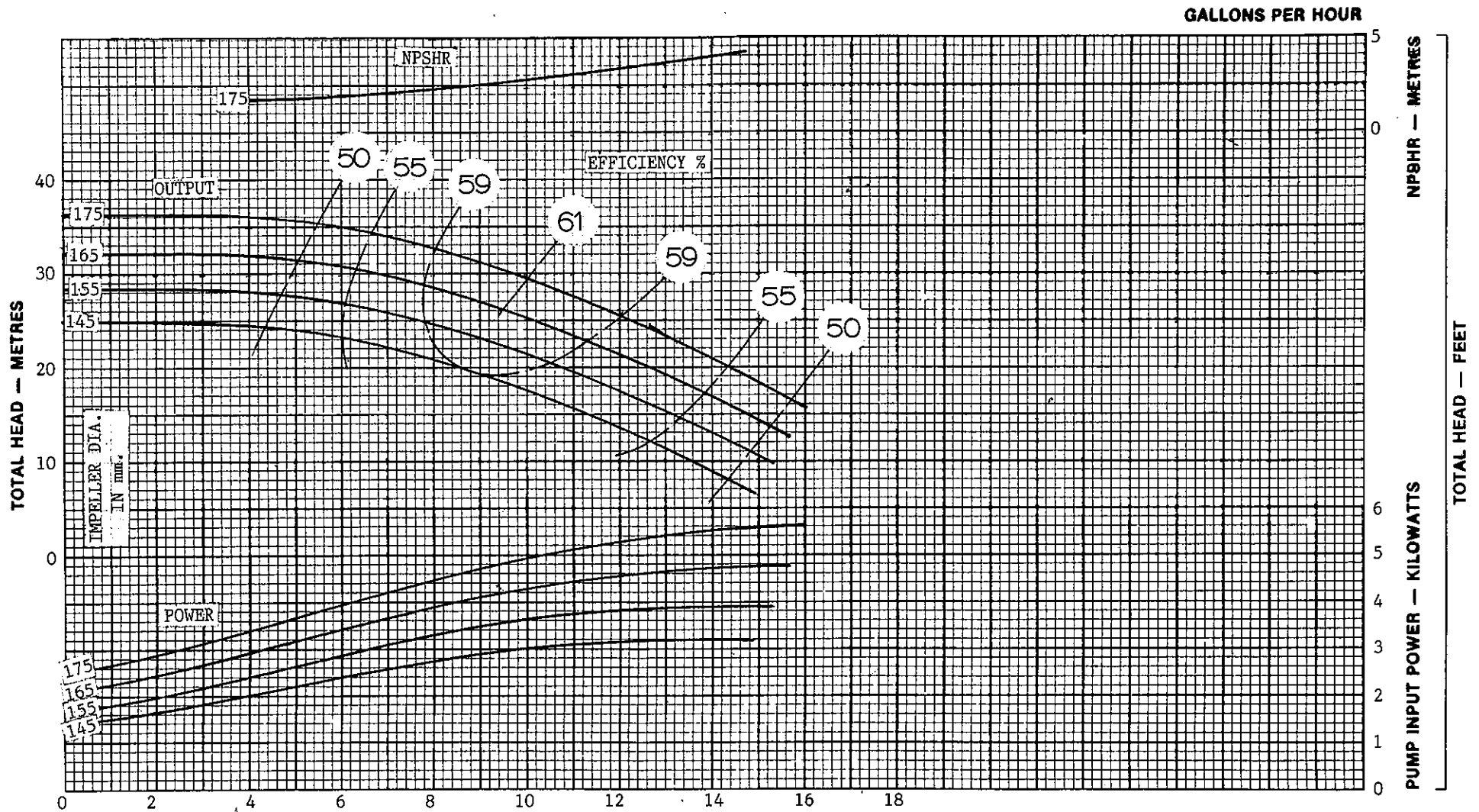

**F.L. STALKER & SONS PTY. LTD.**  
 24 STALKER ROAD, GOSNELLS, W.A.  
 Tel: 398 2133  
 Telex: AA96302

ALL QUALITY ENGINEERED AND MANUFACTURED IN W.A. WITH OVER 60 YEARS EXPERIENCE  
 INSTALLATION, REPAIRS AND SERVICE BORE TESTING & EQUIPMENT, HIRE PUMPS, RE-WINDS (24 Hour Service)

FLOW — LITRES PER SECOND		
PUMP SIZE & TYPE 40 S.H.L.	CLIENT	CURVE NO 12083
IMPELLOR DIA VARIABLE	RPM 2900	DATE 17/10/90
		DRN BY R. SCADDAN

# F.L. STALKER & SONS PTY. LTD.

24 STALKER ROAD, GOSNELLS, W.A.

Tel: 398 2133  
Telex: AA96302

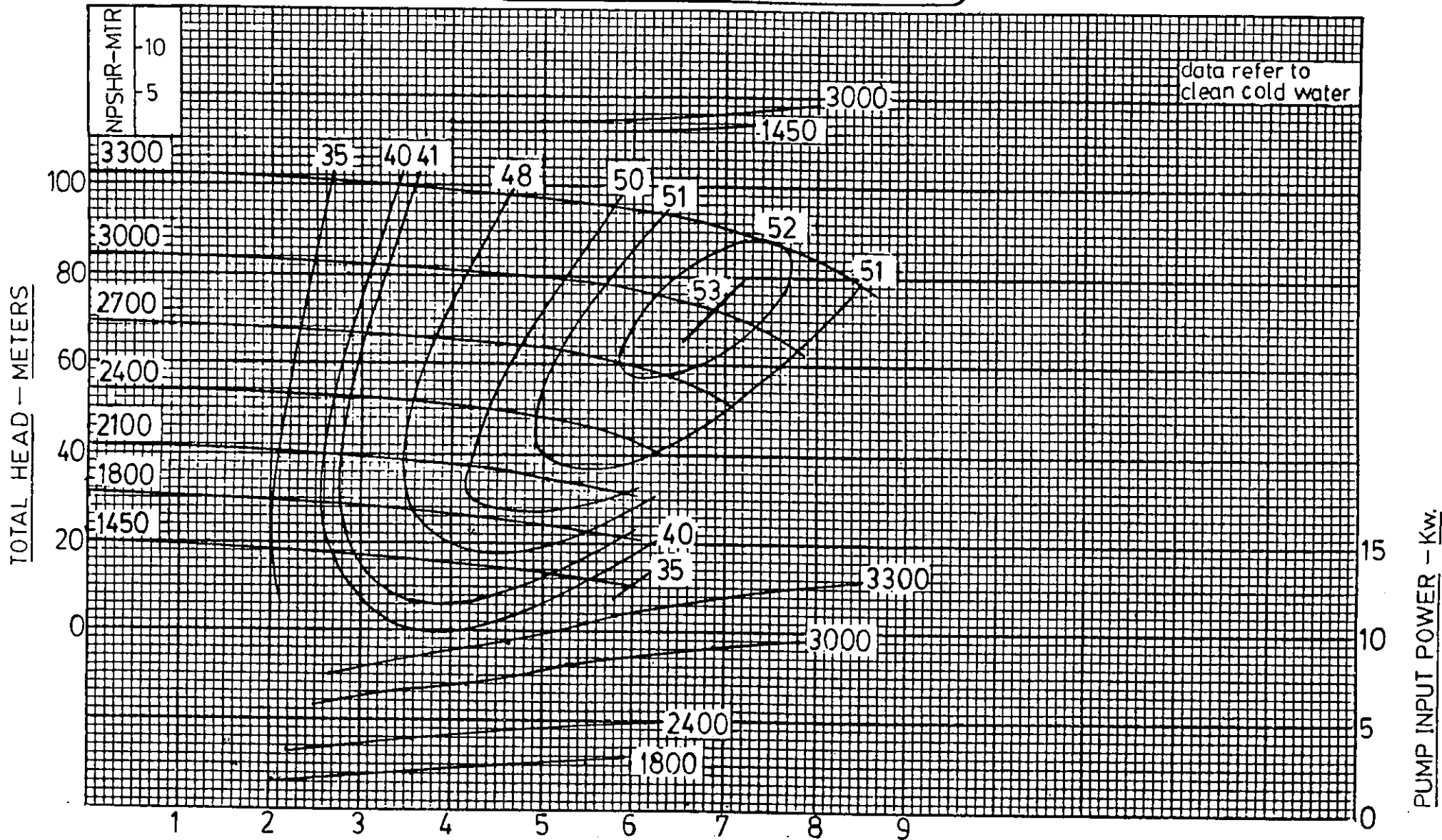

## F.L. STALKER & SONS PTY. LTD.

24 STALKER ROAD, GOSNELLS, W.A.

Tel: 398 2133  
Telex: AA96302

ALL QUALITY ENGINEERED AND MANUFACTURED IN W.A.  
WITH OVER 30 YEARS EXPERIENCE

INSTALLATION, REPAIRS AND SERVICE BORE TESTING  
& EQUIPMENT, HIRE PUMPS, RE-WINDS (24 Hour Service)

### FLOW — LITRES PER SECOND

PUMP SIZE & TYPE 40 SP	CLIENT	CURVE NO 13067
IMPELLOR DIA 236 mm	RPM VARIOUS	DATE
		DRN BY F.E.J.

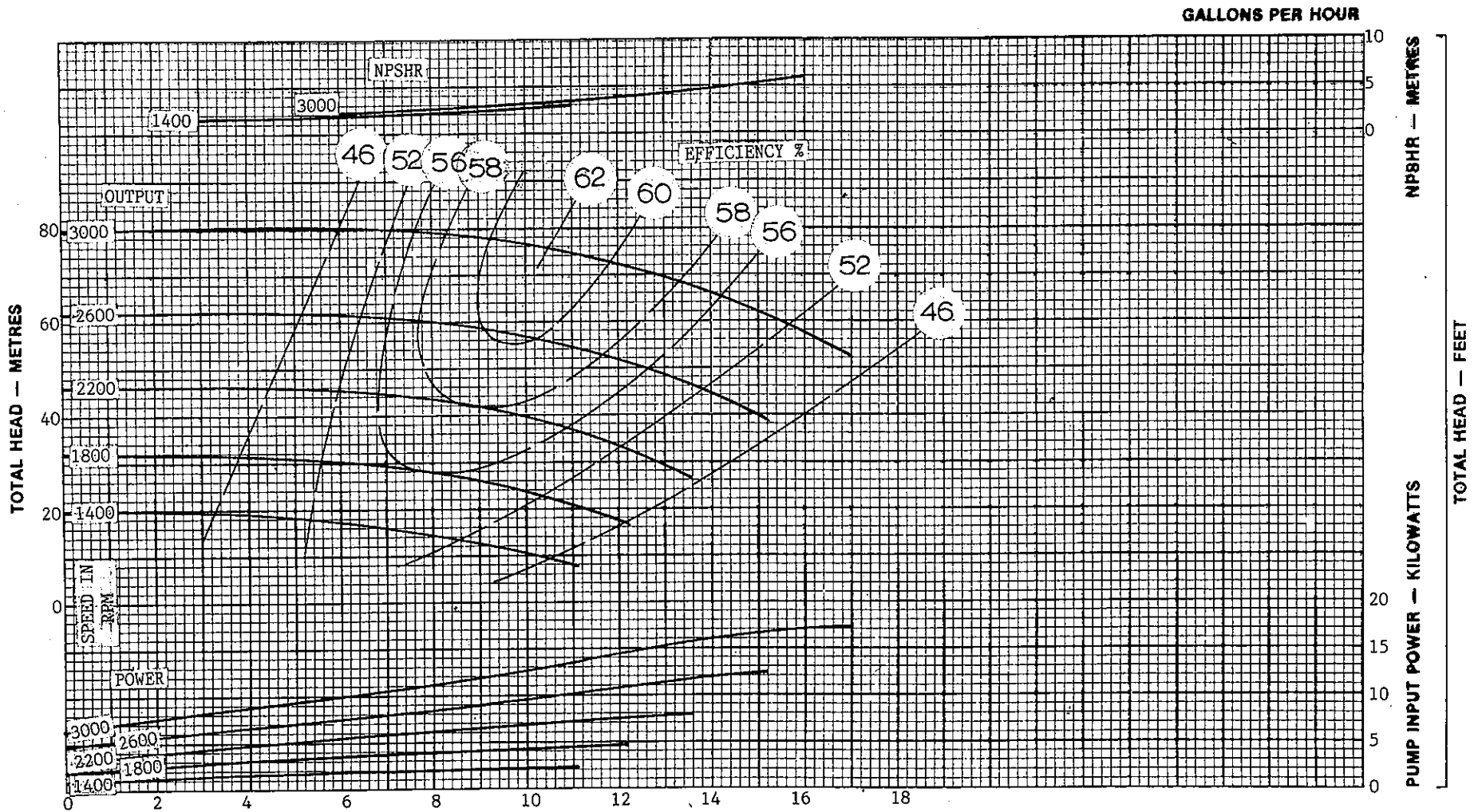

**F.L. STALKER & SONS PTY. LTD.**  
 24 STALKER ROAD, GOSNELLS, W.A.  
 Tel: 398 2133  
 Telex: AA06302

ALL QUALITY ENGINEERED AND MANUFACTURED IN W.A. WITH OVER 60 YEARS EXPERIENCE

INSTALLATION, REPAIRS AND SERVICE BORE TESTING & EQUIPMENT, HIRE PUMPS, RE-WINDS (24 Hour Service)

**FLOW — LITRES PER SECOND**

<b>PUMP SIZE &amp; TYPE</b> 50 S.H.L.	<b>CLIENT</b>		<b>CURVE NO</b> 12015
<b>IMPELLOR DIA</b> 237 mm	<b>RPM</b> VARIABLE	<b>DATE</b> 8/11/90	<b>DRN BY</b> R. SCADDAN

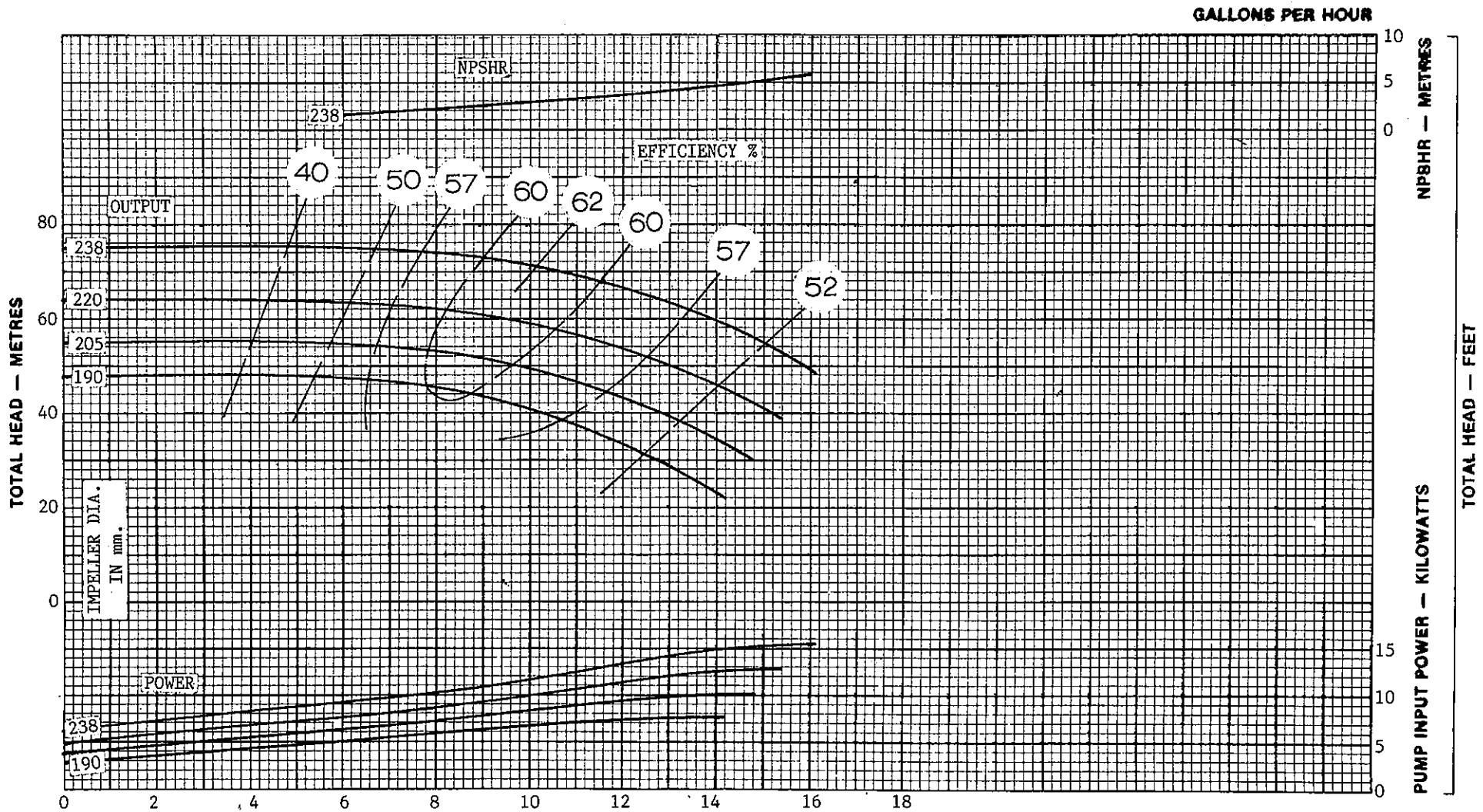

**F.L. STALKER & SONS PTY. LTD.**  
 24 STALKER ROAD, GOSNELLS, W.A. Tel: 398 2133  
 Telex: AA96302

ALL QUALITY ENGINEERED AND MANUFACTURED IN W.A. WITH OVER 60 YEARS EXPERIENCE  
 INSTALLATION, REPAIRS AND SERVICE BORE TESTING & EQUIPMENT, HIRE PUMPS, RE-WINDS (24 Hour Service)

FLOW — LITRES PER SECOND		
PUMP SIZE & TYPE 50 S.H.L.	CLIENT	CURVE NO 12080
IMPELLOR DIA VARIABLE	RPM 2900	DATE 29/10/90
		DRN BY R. SCADDAN

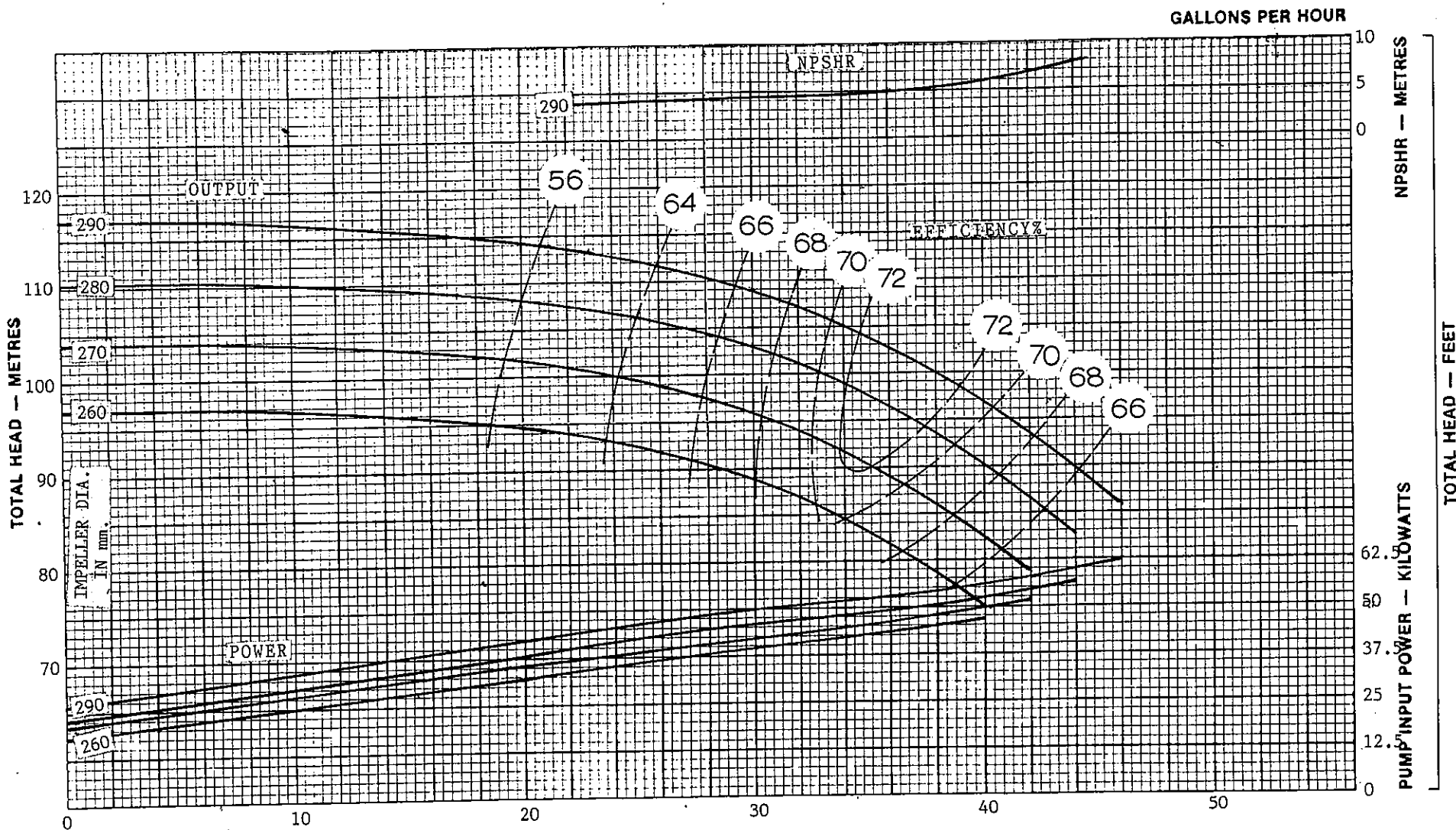

**F.L. STALKER & SONS PTY. LTD.**  
 24 STALKER ROAD, GOSNELLS, W.A.  
 Tel: 398 2133  
 Telex: AA96302

ALL QUALITY ENGINEERED AND MANUFACTURED IN W.A. WITH OVER 50 YEARS EXPERIENCE

INSTALLATION, REPAIRS AND SERVICE BORE TESTING & EQUIPMENT, HIRE PUMPS, RE-WINDS (24 Hour Service)

FLOW — LITRES PER SECOND		CURVE NO	
PUMP SIZE & TYPE		13085	
80 H.L.		DRN BY	
IMPELLOR DIA	RPM	DATE	R. SCADDAN
VARIABLE	2960	23/6/90	

GALLONS PER HOUR

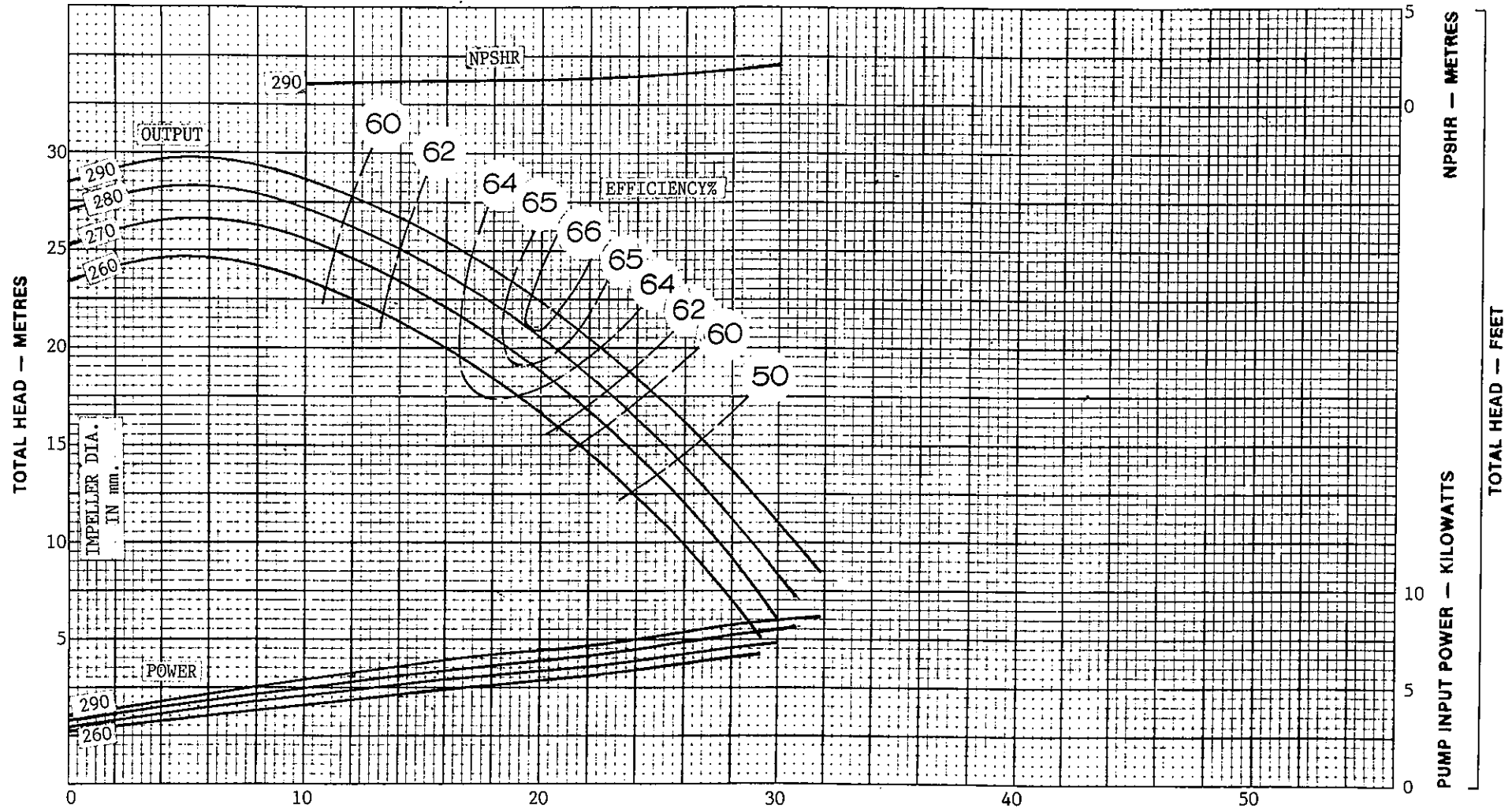

**F.L. STALKER & SONS PTY. LTD.**  
 24 STALKER ROAD, GOSNELLS, W.A. Tel: 398 2133 Telex: AA96302

ALL QUALITY ENGINEERED AND MANUFACTURED IN W.A. WITH OVER 60 YEARS EXPERIENCE

INSTALLATION, REPAIRS AND SERVICE BORE TESTING & EQUIPMENT, HIRE PUMPS, REWINDS (24 Hour Service)

FLOW — LITRES PER SECOND

PUMP SIZE & TYPE 80 H.L.	CLIENT	CURVE NO 13086	
IMPELLOR DIA VARIABLE	RPM 1450	DATE 26/6/90	DRN BY R. SCADDAN

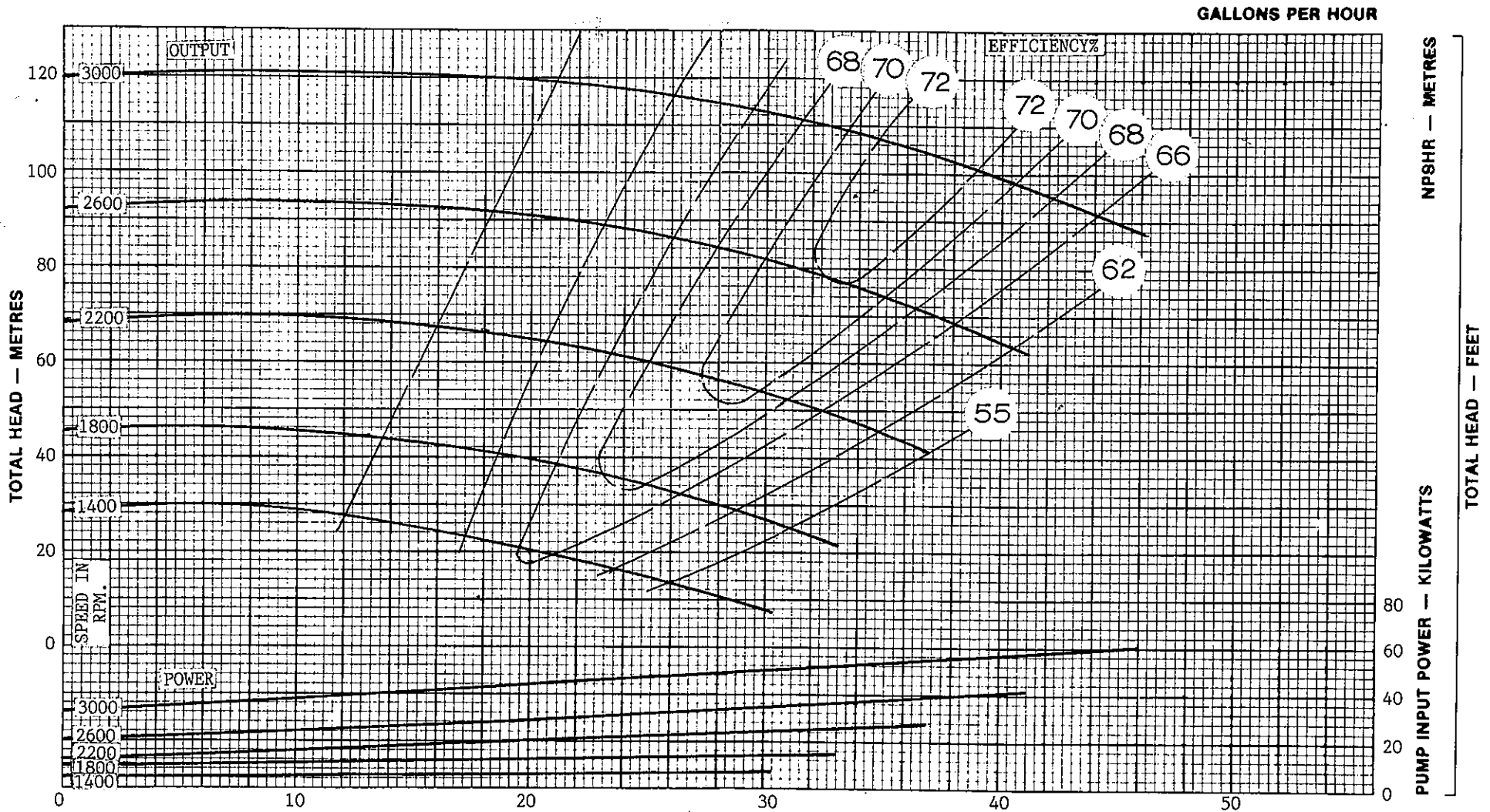

**F.L. STALKER & SONS PTY. LTD.**  
 24 STALKER ROAD, GOSNELLS, W.A. Tel: 398 2133 Telex: AA96302

ALL QUALITY ENGINEERED AND MANUFACTURED IN W.A. WITH OVER 50 YEARS EXPERIENCE

INSTALLATION, REPAIRS AND SERVICE BORE TESTING & EQUIPMENT, HIRE PUMPS, RE-WINDS (24 Hour Service)

**FLOW — LITRES PER SECOND**

<b>PUMP SIZE &amp; TYPE</b> 80 H.L.	<b>CLIENT</b>	<b>CURVE NO</b> 13087
<b>IMPELLOR DIA</b> 290 mm	<b>RPM</b> VARIABLE	<b>DATE</b> 27/6/90
		<b>DRN BY</b> R. SCADDAN



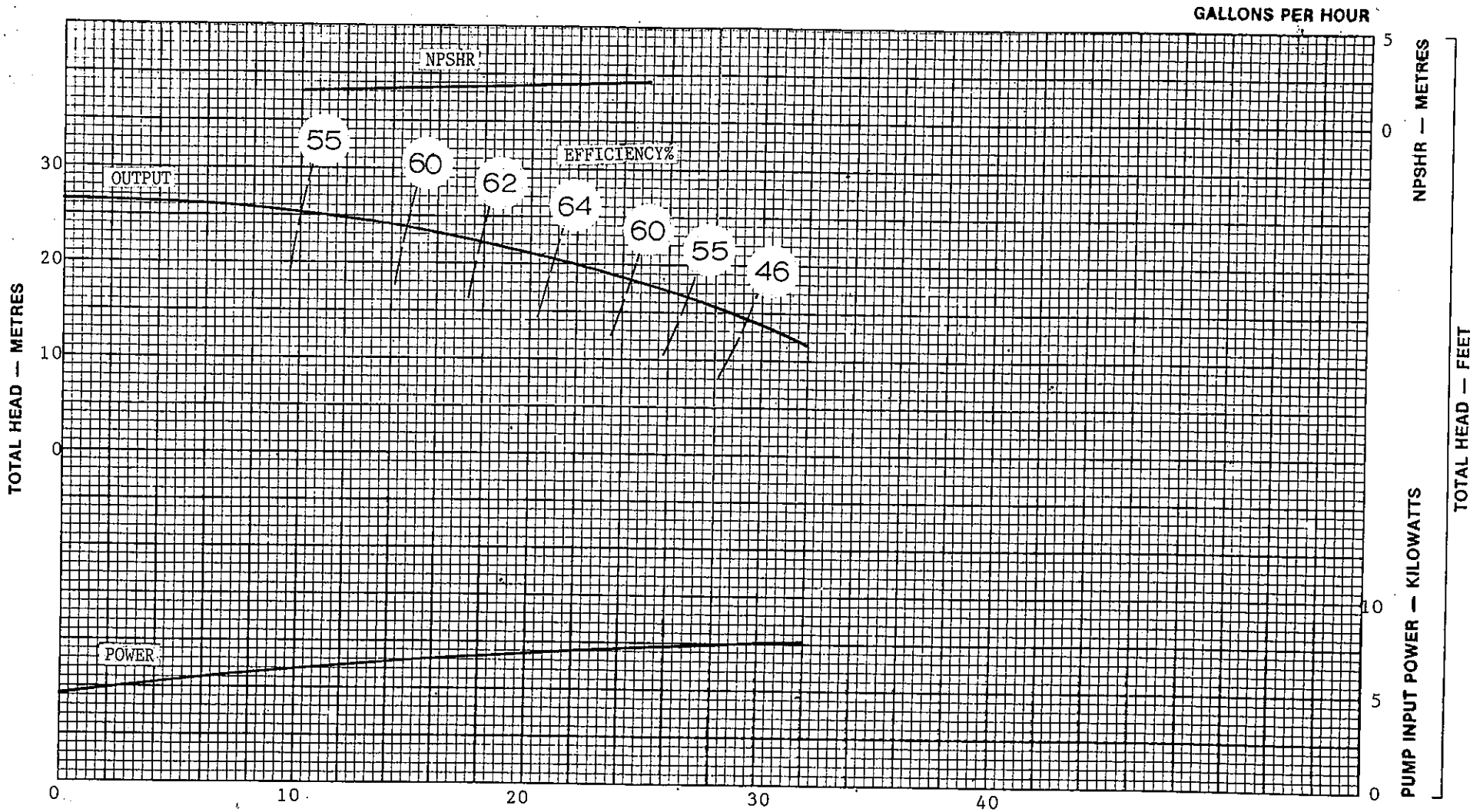

# F.L. STALKER & SONS PTY. LTD.

24 STALKER ROAD, GOSNELLS, W.A.

Tel: 398 2133  
Telex: AA96302

ALL QUALITY ENGINEERED AND MANUFACTURED IN W.A.  
WITH OVER 60 YEARS EXPERIENCE

INSTALLATION, REPAIRS AND SERVICE BORE TESTING  
& EQUIPMENT, HIRE PUMPS, RE-WINDS (24 Hour Service)

## FLOW — LITRES PER SECOND

PUMP SIZE & TYPE 3" SEWAGE	CLIENT		CURVE NO 12118
IMPELLOR DIA 228mm	RPM 1450	DATE 20/4/90	DRN BY R. SCADDAN